

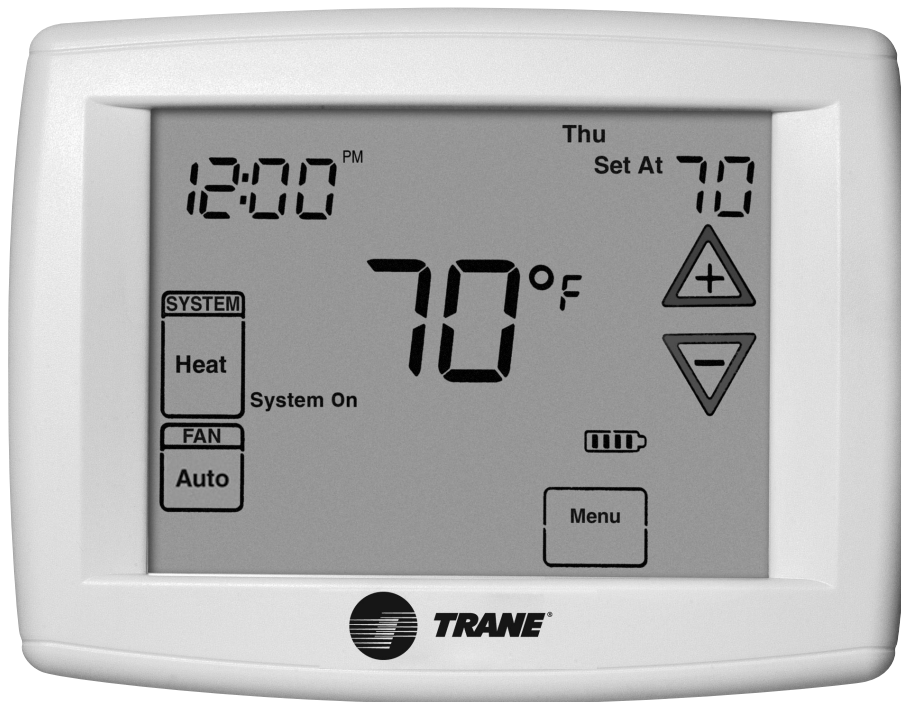

**TRANE®**

# Trane Touchscreen Thermostat

## TCONT302 and 303 Installation and User Guide



ALL phases of this installation must comply with NATIONAL, STATE AND LOCAL CODES

**IMPORTANT** — This Document is customer property and is to remain with this unit.

These instructions do not cover all variations in systems or provide for every possible contingency to be met in connection with the installation. Should further information be desired or should particular problems arise which are not covered sufficiently for the purchaser's purposes, the matter should be referred to your installing dealer or local distributor.

# Contents

1. Safety.....	2	1 Stage Heat Pump with GAF2-s.....	12
2. Product Specifications.....	3	Package Heat / Cool Unit .....	12
3. General Information .....	3	6. Thermostat Quick Reference.....	13
3.1 Overview .....	3	7. Installer Configuration Menu.....	14-18
3.2 Contents .....	3	8. User Guide .....	19
3.3 Accessories.....	3	8.1 Fan Operation.....	19
4. Installation .....	4	8.2 Heating.....	19
4.1 Location .....	4	8.3 Humidifier Option.....	19
Figure 1: Placement		8.4 Emergency Mode (Heat).....	19
4.2 Mounting.....	4	8.5 Cooling.....	19
4.3 Battery Location.....	4	8.6 Cooling Dehumidification .....	19
4.4 Power Stealing Switch.....	4	8.7 Fan Settings .....	19
4.5 Heat/Cool Applications.....	5	8.8 System Setting.....	20
Figure 2: Thermostat Base Plate		8.9 Manual Operation (Non-Programmable Mode).....	20
Figure 3: Terminal Designations Single State or Multi-Stage		8.10 Manual Operation (Programmable Mode).....	20
System: Heat / Cool Systems		8.11 Program Override .....	20
Figure 4: Heat Pump Systems		9. Programming .....	
5 Wiring Diagrams		9.1 Setting Time and Day.....	20
1 or 2 Stage AC with TAM9 or TAM7 .....	6	9.1.1 Automatic Daylight Saving Calculation .....	20
1 Stage AC with TEM3, TEM4, GAT2, GAM2.....	6	9.2 Programming Tip.....	20
1 or 2 Stage AC with TEM6.....	7	9.3 Enter the Heating Program .....	21
1 or 2 Stage AC with GAM5B.....	7	9.4 Enter the Cooling Program .....	21
AC / Cooling with GAF2-S.....	8	9.5 Automatic Schedule .....	
1 or 2 Stage Heat Pump with TAM9 or TAM7 .....	8	10. Planning Your Program .....	21
2 Stage Heat Pump with GAM5B.....	9	Worksheet for Re-Programming .....	22
1 or 2 Stage Heat Pump with Variable Speed Furnace.....	9	11 Wired Remote Temperature Sensing.....	23
1 or 2 Stage Heat Pump with S9V2 Furnace .....	10	11.1 Averaging or Weighting Remote Sensors.....	23
1 or 2 Stage Heat Pump with TAM4, GAM5A, GAF2-36M .....	10	11.2 Dual Fuel Temperature Setpoint .....	23
1 or 2 Stage Heat / Cool Pkg Unit with VSB .....	11	11.3 Blower Blance Point for Heating .....	23
HP Pkg Unit with Non-Variable SB.....	11	Trouble Shooting .....	24

## 1. Safety

### WARNING

**FAILURE TO READ AND FOLLOW ALL INSTRUCTIONS CAREFULLY BEFORE INSTALLING OR OPERATING THIS CONTROL COULD CAUSE PERSONAL INJURY AND/OR PROPERTY DAMAGE.**

This information is intended for use by individuals possessing adequate backgrounds of electrical, mechanical, HVAC and experience. Any attempt to repair a HVAC system may result in personal injury and/or property damage. The manufacturer or seller cannot be responsible for the interpretation of this information, nor can it assume any liability in connection with its use.

#### LIVE ELECTRICAL COMPONENTS!

During installation, testing, servicing, and troubleshooting of this product, it may be necessary to work with live electrical components. Failure to follow all electrical safety precautions when exposed to live electrical components could result in death or serious injury.

Thermostat installation and all components of the control system shall conform to Class II circuits per the NEC code.

### CAUTION

To prevent electrical shock and/or equipment damage, disconnect electric power to system at main fuse or circuit breaker box until installation is complete.

#### ATTENTION: MERCURY NOTICE

This product does not contain mercury. However, this product may replace a product that contains mercury. Mercury and products containing mercury must not be discarded in household trash. Do not touch any spilled mercury. Wearing non-absorbent gloves, clean up any spilled mercury and place in a sealed container. For proper disposal of a product containing mercury or a sealed container of spilled mercury, place it in a suitable shipping container. Refer to [www.thermostat-recycle.org](http://www.thermostat-recycle.org) for location to send the product containing mercury.

**NOTE:** Use 18-gauge color-coded thermostat cable for proper wiring. Shielded cable is not typically required.

Keep this wiring at least one foot away from large inductive loads such as Electronic Air Cleaners, motors, line starters, lighting ballasts and large distribution panels. Failure to follow these wiring practices may introduce electrical interference (noise) which can cause erratic system operation.

All unused thermostat wire to be grounded at indoor unit chassis ground only. Shielded cable may be required if the above wiring guidelines cannot be met. Ground only one end of the shield to the system chassis.

## 2. Product Specifications

SPECIFICATION	DESCRIPTION	
Product Models	TCONT302 / TCONT303	
Products	XR 302 / XR 303	
Size	4-9/16" x 5-13/16" x 1-3/16" (HxWxD)	
Configurations	Heat Pump, Heat/Cool, Dual Fuel, Heat Only, Cooling Only	
Maximum Number of Stages	4 Stages Heat, 2 Stages Cooling	
Operating Temperature	32°F to 105°F (0 to +41°C) / 90% RH Non Condensing	
Shipping Temperature Range	-40 to 150°F (-90 to +65°C)	
Input Power (DC)	Two 1.5V AA Alkaline	
Input Power (AC)	20-30 VACm NEC Class 11m 50/60 HZ	
Terminal Load	1.5A per Terminal, 2.5A Maximum, all Terminals Combined	
Wire Usage	18 AWG	
System Modes	Auto, Heating, Cooling, Off, Emergency Heat	
Fan Modes	Auto, On, Program	
Setpoint Temperature Range	45°F to 99°F, (7 to 37°C)	
Humidification Setpoint Range	5 to 50% (303 only)	
Dehumidification Setpoint Range	40 TO 95% (303 only)	
Indoor Temperature Display Range	32°F to 99°F	
Outdoor Temperature Display Range	-40°F to 140°F	
Indoor Humidity Display Range	0°F to 100°F	
RATED DIFFERENTIALS		
	Fast	Slow
Heat (Single Stage/Multi-Stage)	0.6°F	1.5F
Cool (Single Stage/Multi-Stage)	1.2°F	1.7°F
Heat Pump	1.2°F	1.7°F
Emer Heat	0.6°F	1.7°F
THERMOSTAT APPLICATION GUIDE		
Thermostat Configuration Options	Thermostat Applications	Maximum Stages Heat/Cool
Single Stage 1 No Heat Pump (SS1)	Gas, Oil, Electric, Heat Only, Cool Only or Heat/Cool Systems, 2 or 3 wire Hydronic Zone (Hot Water or Steam) Systems, 24 Volt or Millivolt	1+1
Multi Stage 2 No Heat Pump (MS2)		2+2
Heat Pump 1 Single Stage Compressor Heat Pump (HP1)	Single Stage Compressor Heat Pump Systems - up to 2 Stages Aux./Emergency Heat	3+1
Heat Pump 2 Two Stage or Two Compressor Heat Pump (HP2)	Two Stage or Two Compressor Heat Pump systems - up to 2 Stages Aux./Emergency Heat	4+2

\*On every application, 24VAC loads should be reviewed to be sure the indoor unit control power transformer is adequately sized.

## 3. General Information

### 3.1 Overview

The 302 and 303 are programmable thermostats with 5" diagonal, blue backlit, touchscreen displays. The 303 features a built-in humidity sensor that may be used to control a whole house humidifier (HM) and cooling dehumidification (DHM).

### 3.2 Contents

- 1-Thermostat
- 1-Sub-base
- 2-Phillips slotted head mounting screws
- 2-Nylon Drywall Anchors
- 1-Installation Guide / User Guide

### 3.3 Accessories

- Wired Remote Indoor Sensor ZZSENSAL0300AAA
- Wired Remote Outdoor Sensor BAYSEN30ATEMPAA
- Wall Cover Plate BAYCOVR300AA

## 4. Installation

### 4.1 Location

The 302 and 303 is designed for installation in climate controlled living spaces. Place the unit in a central location with good circulation.

For proper temperature sensing, avoid exposing the 302 and 303 to heat radiated from lamps, sun light, fireplaces or any other radiant heat source.

Avoid locations close to windows, behind doors or alcoves with poor air circulation, adjoining outside walls, or doors that lead to the outside.

Select a location that prevents the 302 and 303 from being directly exposed to air currents from supply registers or ceiling fans.

Mount the Control on a section of interior wall that does not contain hot or cold water pipes or duct work.

**FIGURE 1. PLACEMENT OF THE 302 AND 303**

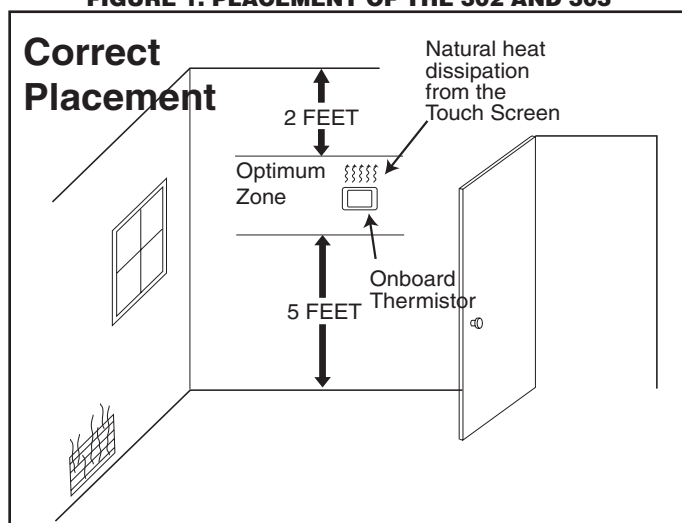

### 4.2 Mounting / Installation

Follow these steps to mount the 302 and 303 Control to the wall.

1. Turn OFF all power to heating and cooling equipment.
2. If an existing thermostat is being replaced:
  - a. Remove the existing thermostat from the wall.
  - b. Record color and terminal marking of each wire.
  - c. Disconnect the wires from the existing thermostat being careful not to allow them to fall back into the wall.
3. Pull the thermostat body off the thermostat base. Forcing or prying on the thermostat will cause damage to the unit.
4. Place base over hole in wall and mark mounting hole locations on wall using base as template. (See Fig. 1)
5. Move base out of the way. Drill mounting holes. If you are using existing mounting holes and the holes drilled are too large and do not allow you to tighten base snugly, use plastic screw anchors to secure the base.
6. Fasten base snugly to wall using mounting holes shown in Figure 1 and two mounting screws. Leveling is for appearance only and will not affect thermostat operation.
7. Connect wires to terminal block on base using appropriate wiring diagram.

8. Push excess wire into wall and plug hole with a fire resistant material (such as fiberglass insulation) to prevent drafts from affecting thermostat operation.
9. Carefully line the thermostat up with the base and snap into place.

### **⚠ WARNING**

**Thermostat installation and all components of the control system shall conform to Class II circuits per the NEC code.**

### 4.3 Battery Location

Two "AA" alkaline batteries are included in the thermostat at the factory with a battery tag to prevent power drainage. Remove the battery tag to engage the batteries.

To replace batteries, set system to OFF, remove thermostat from wall and install the batteries in the rear along the top of the thermostat (see Figure 2). For best results, use a premium brand "AA" alkaline battery such as Duracell® or Energizer®. If the home is going to be unoccupied for an extended period (over 3 months) and  is displayed, the batteries should be replaced before leaving.

### 4.4 Power Stealing Switch

The power stealing switch is set to OFF. Placing the switch in the ON position may extend battery life. Power stealing is not compatible with every furnace. Cycle the furnace and verify the inducer and/or indoor blower do not run continuously or with no call for heat. If they do, return switch to OFF position.

**FIGURE 2. THERMOSTAT BASE PLATE 302 / 303**

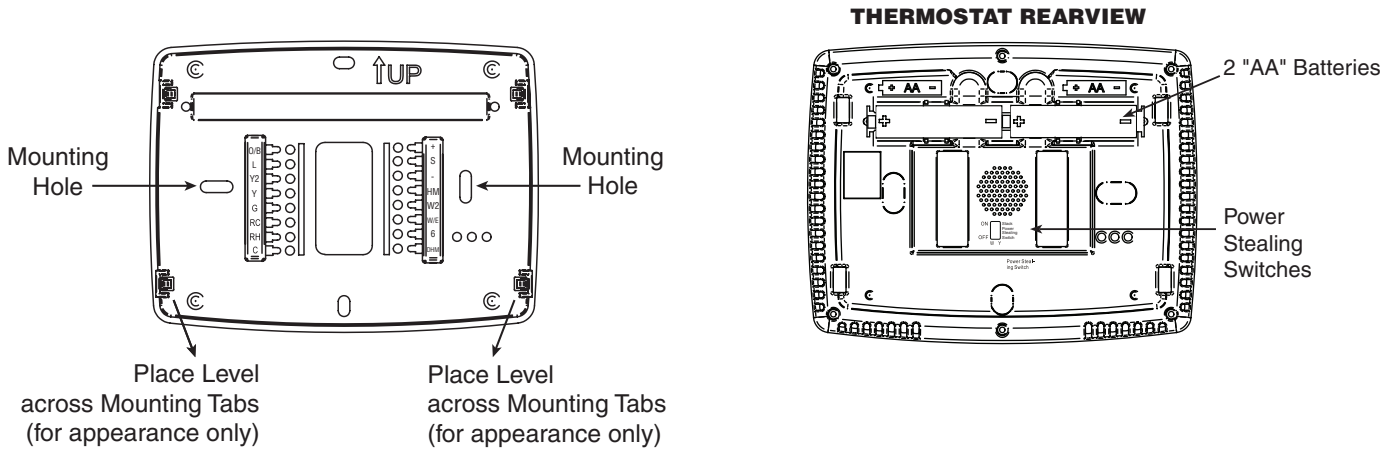

**COOLING DEHUMIDIFICATION, HUMIDIFICATION, AND REMOTE TEMPERATURE SENSOR TERMINALS**

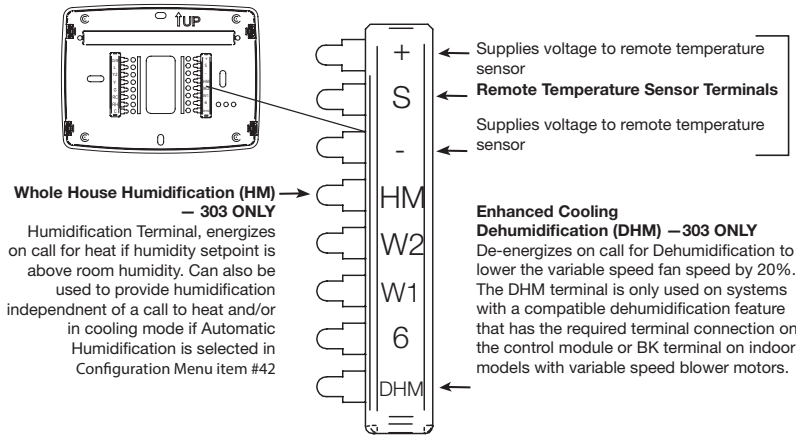

**FIGURE 3. – TERMINAL DESIGNATIONS SINGLE STAGE OR MULTI-STAGE SYSTEM: Heat / Cool Systems**

System	RC	RH	C	Y	Y2	W/E	W2	G	O/B	6	L
Single Stage 1 (SS1)			24 volt common (optional for system operation, required for remote sensor)	Call for cool	No Output	Call for heat	No output	Blower/Circulator fan energized on a call for cool or Fan On (also energized in heating if configured for Electric Heat)	Installer Configuration Menu selects "O" or "B" for changeover function. Set to "O" terminal energized in Cool & Off mode. Set to "B" terminal energized in Heat & emergency mode	Power closed connection for SPDT 3-wire zone valve	Fault or System Malfunction Indicator for Heat Pumps with "L" terminal connection.
Multi Stage 2 (MS2)	24 volt power for cooling	24 volt power for heating		Cool mode-1st stage	Cool mode-2nd stage	Heat mode-1st stage	Heat mode-2nd stage				

**FIGURE 4. – HEAT PUMP SYSTEMS**

System	RC	RH	C	Y	Y2	*W/E	*W2	G	O/B	6	L
Heat Pump 1 (HP1)			24 volt common (optional for system operation, required for remote sensor)	Heat mode-1st stage, Cool mode-1st stage, (Compressor)	No Output	Heat mode-2nd stage, Emergency Mode-1st stage <b>*Note: Dual Fuel option de-energizes Heat mode stage 1 (compressor) when auxiliary heat is energized</b>	Heat mode-3rd stage, Emergency Mode-2nd stage <b>*Note: Dual Fuel option de-energizes Heat mode stage 1 (compressor) when auxiliary heat is energized</b>	Blower/Circulator fan energized on a call for cool or Fan On (also energized in heating if configured for Electric Heat)	Installer Configuration Menu selects "O" or "B" for changeover function. Set to "O" terminal energized in Cool & Off mode. Set to "B" terminal energized in Heat & emergency mode	Power closed connection for SPDT 3-wire zone valve	Fault or System Malfunction Indicator for Heat Pumps with "L" terminal connection.
Heat Pump 2 (HP2)	24 volt power for cooling	24 volt power for heating		Heat mode-2nd stage, Cool mode-2nd stage, (Compressor)	Heat mode-3rd stage, Emergency Mode-1st stage	Heat mode-4th stage, Emergency Mode-2nd stage <b>*Note: Dual Fuel option de-energizes Heat mode stages 1 and 2 (both compressors) when auxiliary heat is energized</b>					

## 5. Wiring Diagrams

### 1 or 2 Stage AC with TAM9 or TAM7

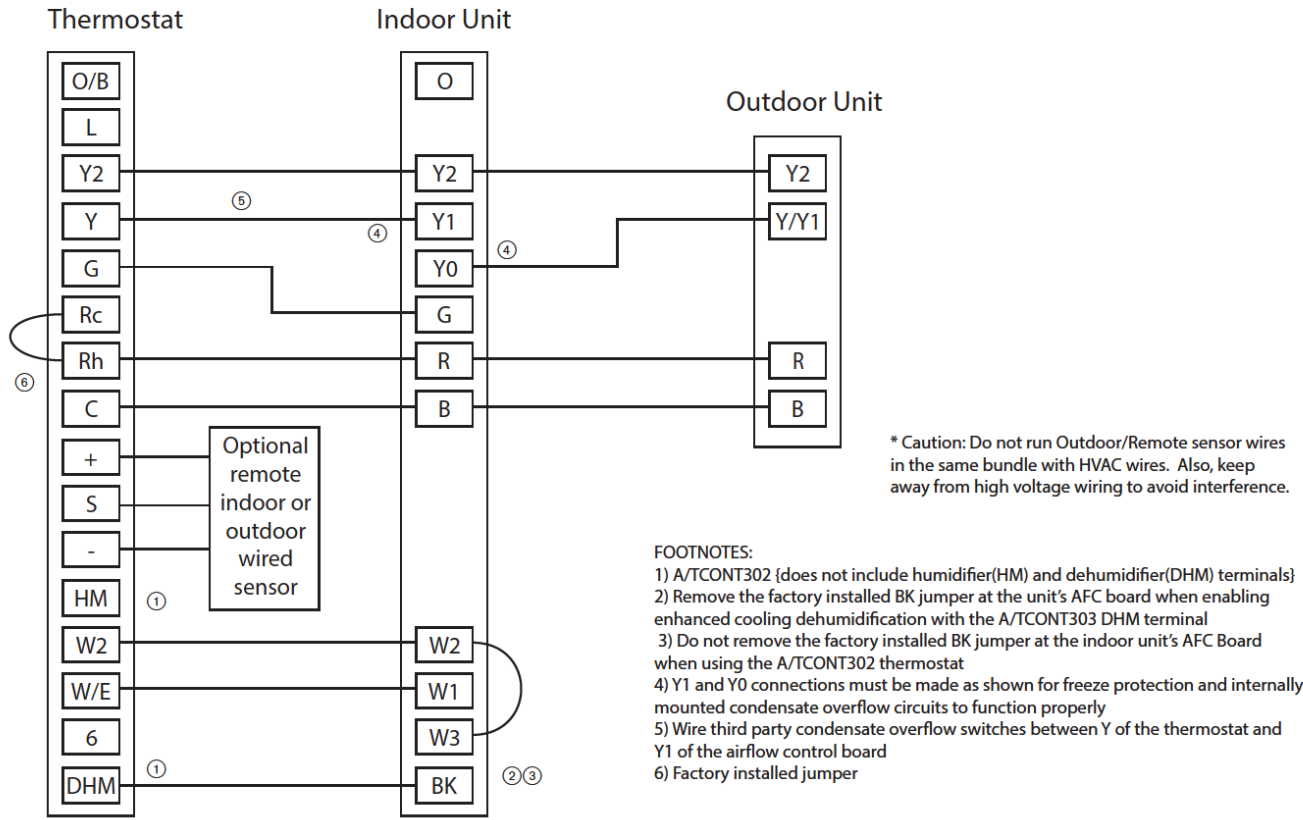

### 1 Stage AC with TEM3, TEM4, GAT2, GAM2

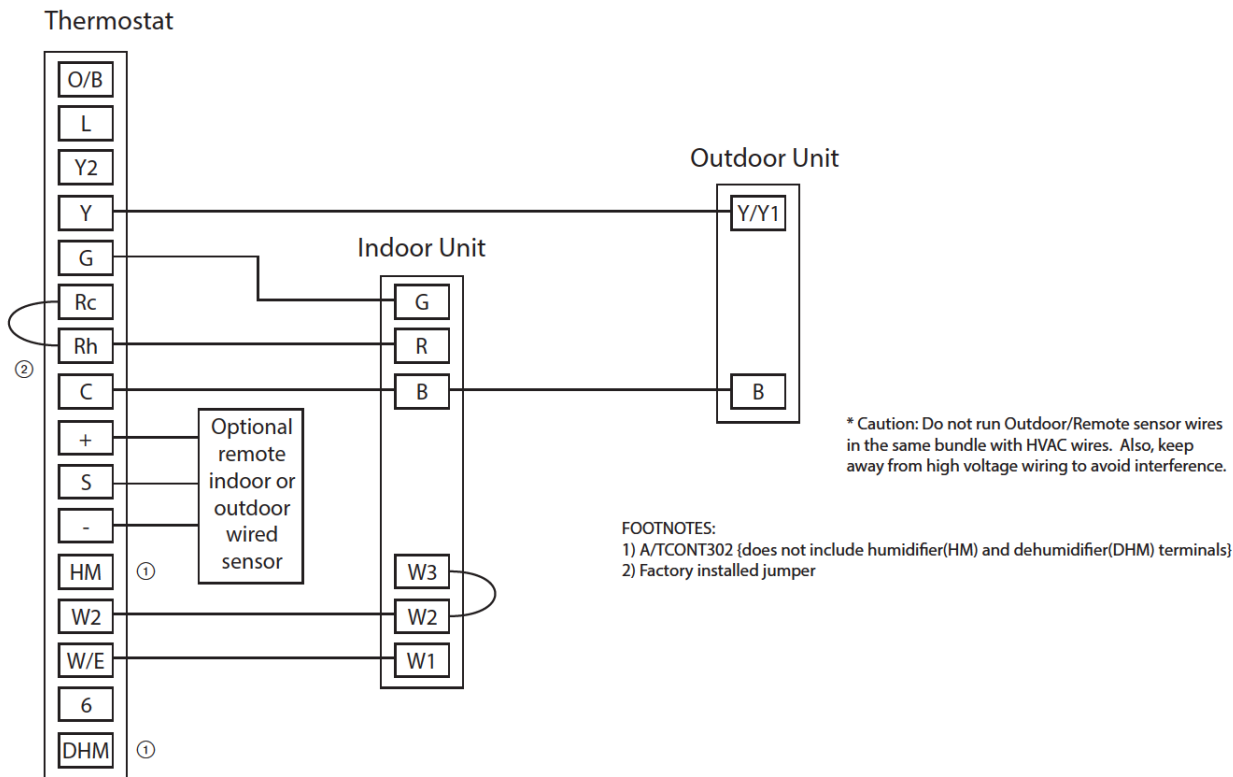

### 1 or 2 Stage AC with TEM6

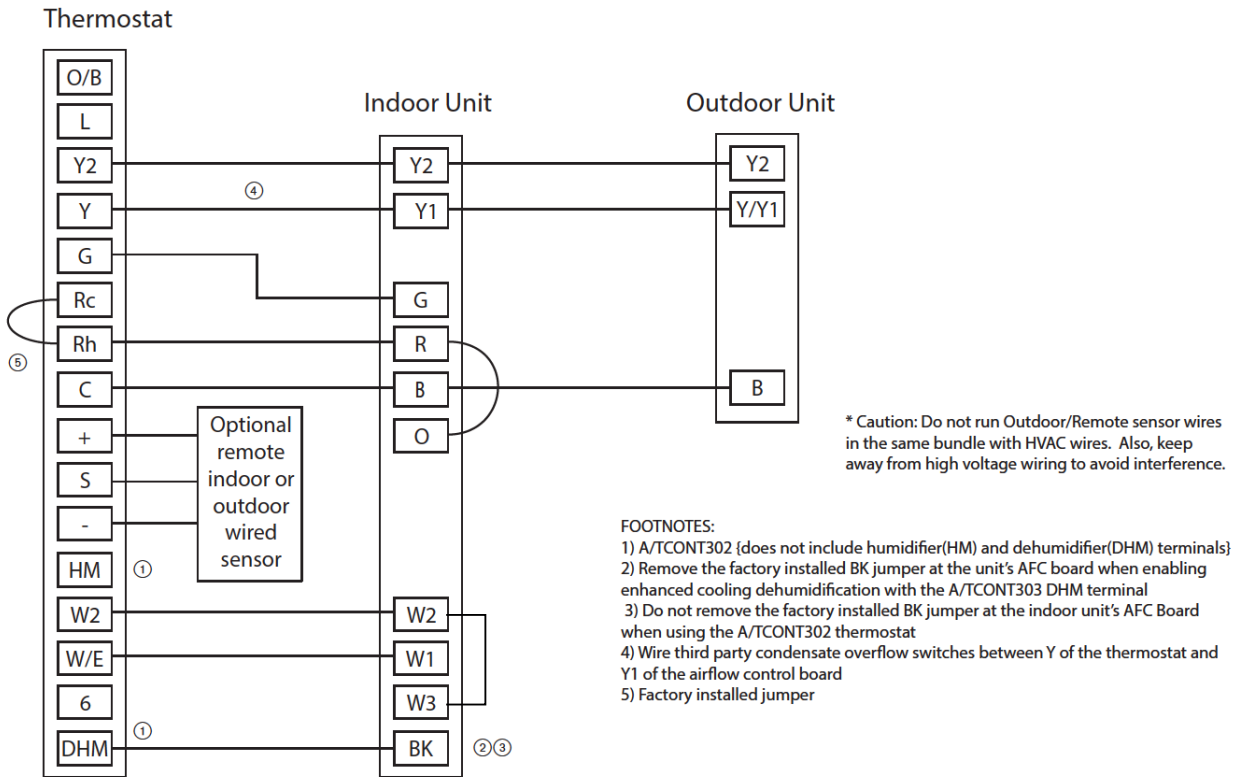

### 1 or 2 Stage AC with GAM5B

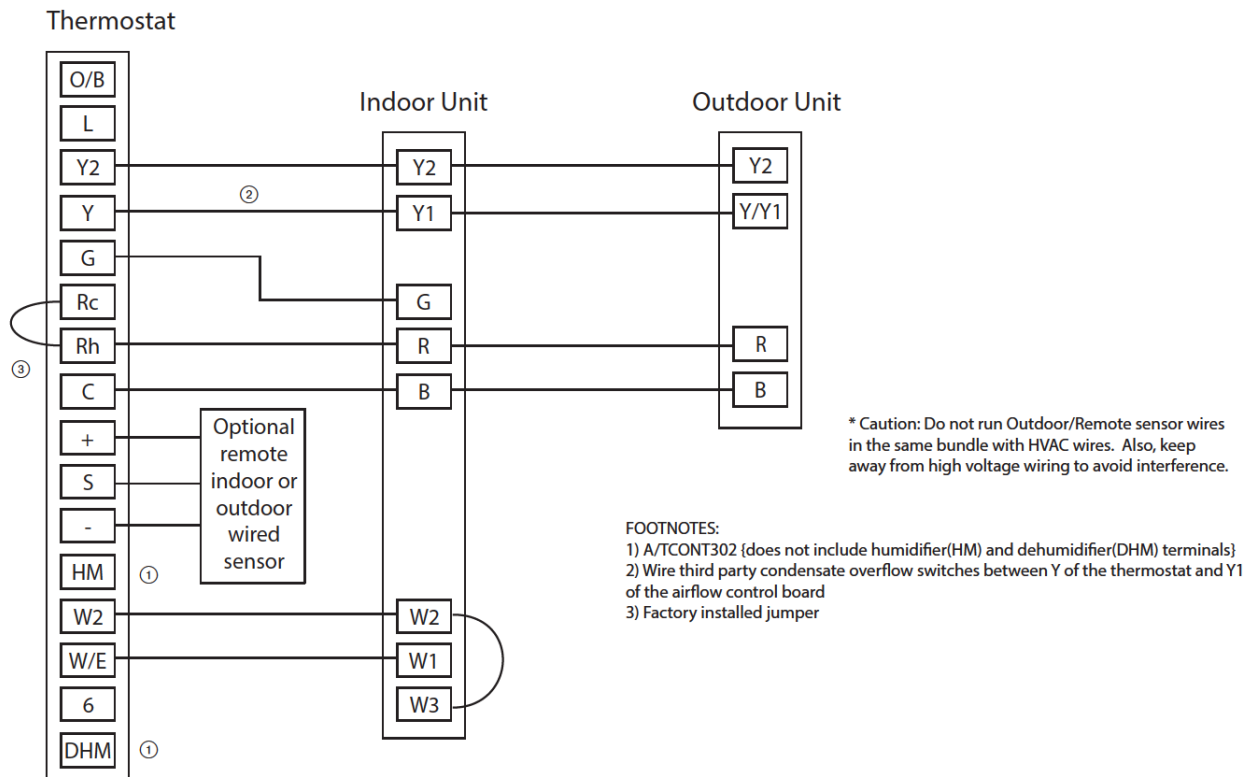



### AC/Cooling with GAF2-S

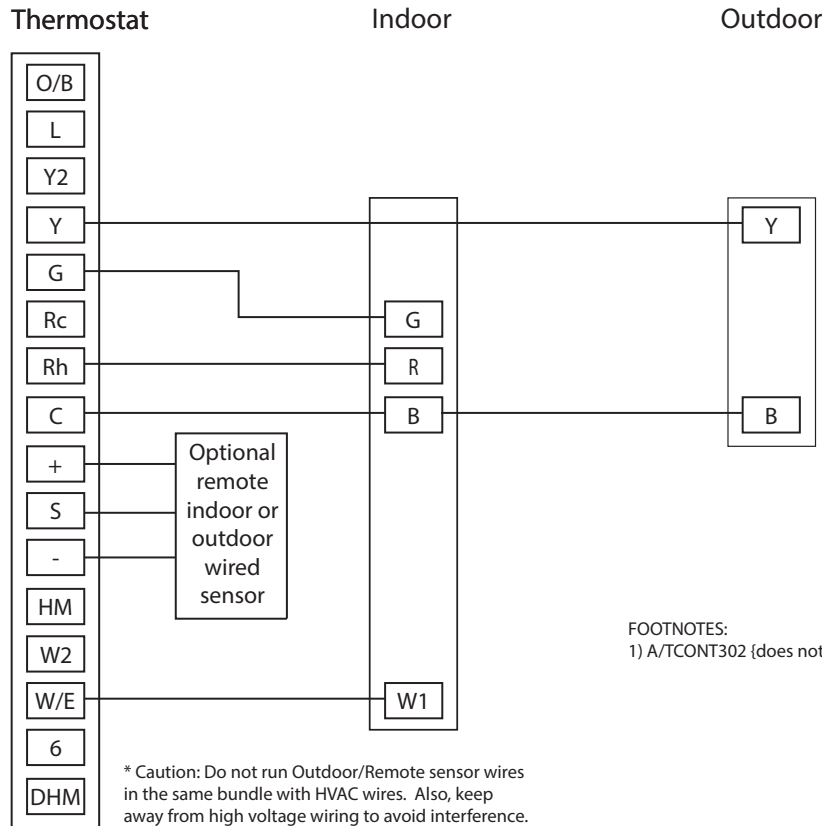

FOOTNOTES:  
1) A/TCONT302 {does not include humidifier(HM) and dehumidifier(DHM) terminals}

### 1 or 2 Stage Heat Pump with TAM9 or TAM7

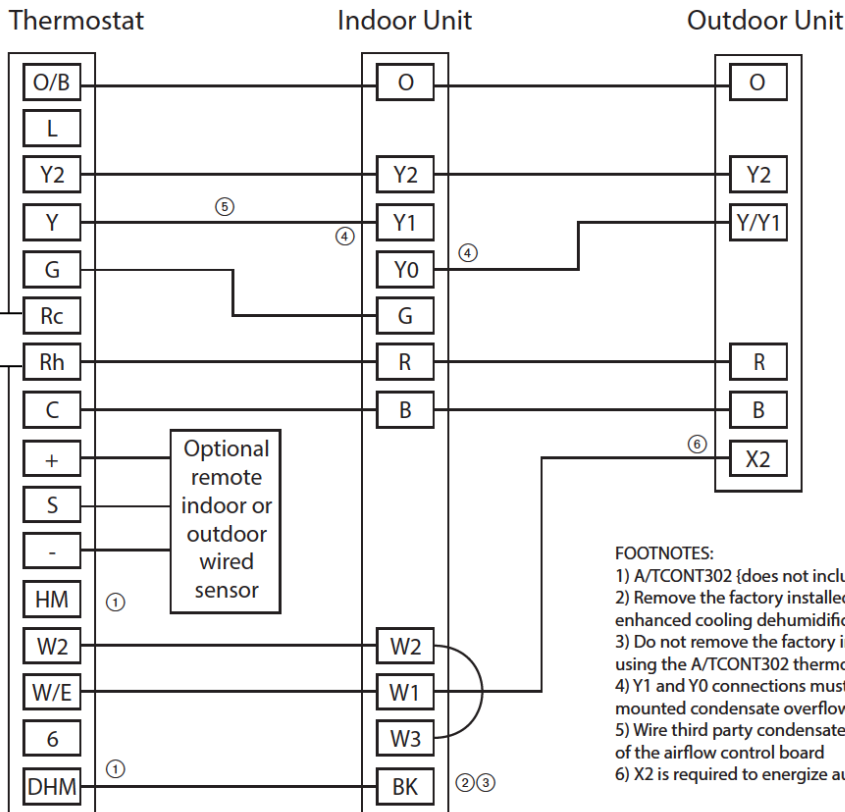

FOOTNOTES:  
1) A/TCONT302 {does not include humidifier(HM) and dehumidifier(DHM) terminals}  
2) Remove the factory installed BK jumper at the unit's AFC board when enabling enhanced cooling dehumidification with the A/TCONT303 DHM terminal  
3) Do not remove the factory installed BK jumper at the indoor unit's AFC Board when using the A/TCONT302 thermostat  
4) Y1 and Y0 connections must be made as shown for freeze protection and internally mounted condensate overflow circuits to function properly  
5) Wire third party condensate overflow switches between Y of the thermostat and Y1 of the airflow control board  
6) X2 is required to energize aux heat during defrost



### 2 Stage Heat Pump with GAM5B

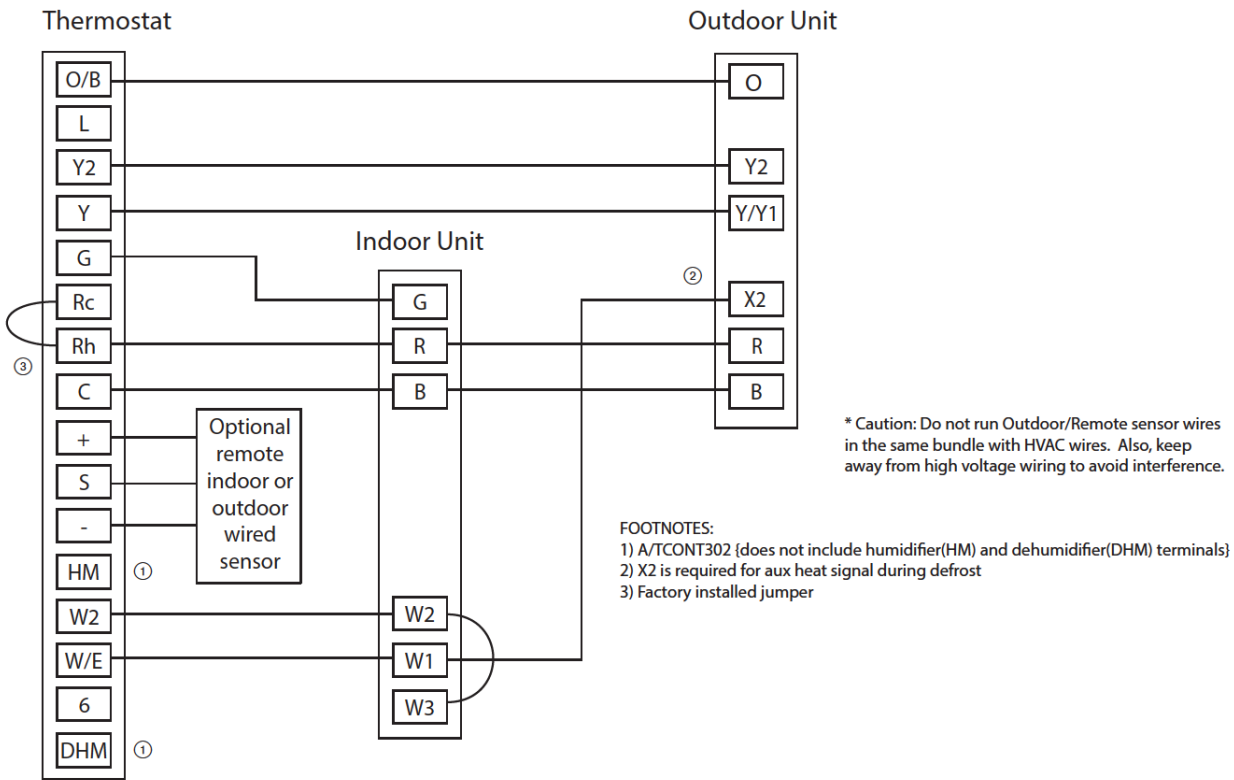

### 1 or 2 Stage Heat Pump with Variable Speed Furnace

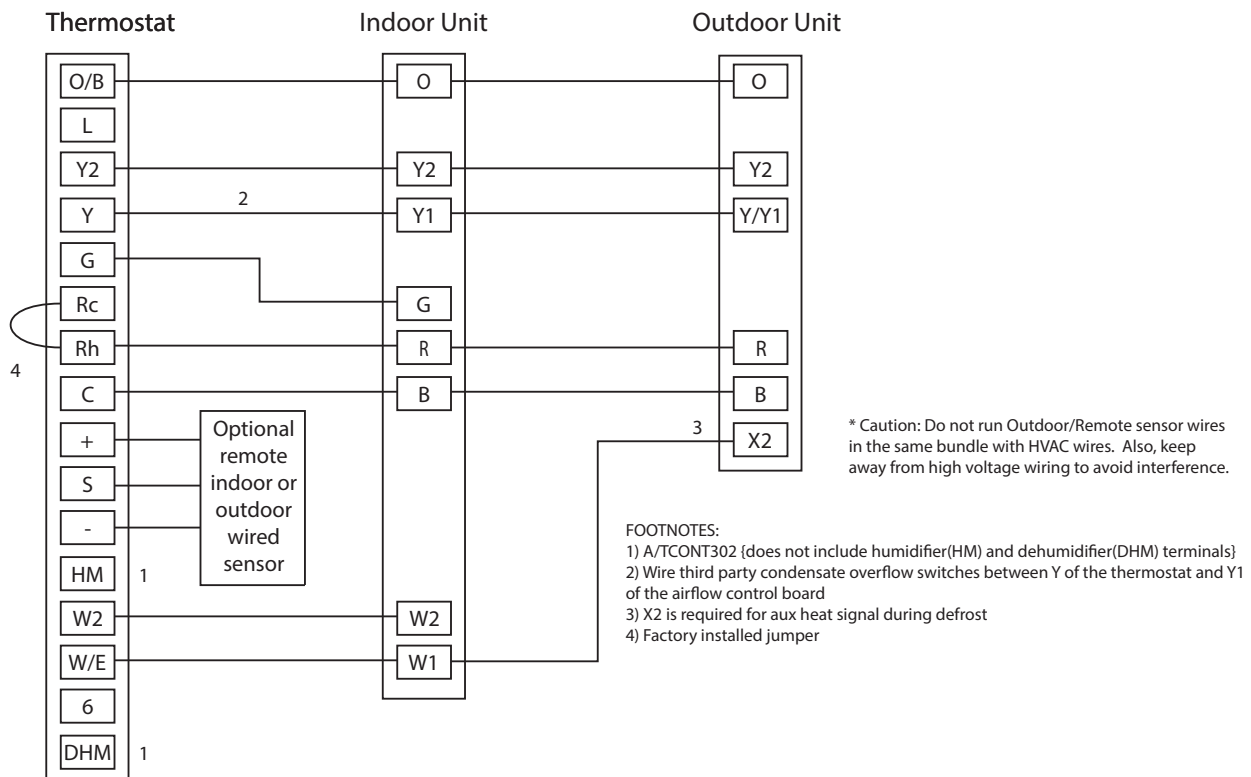

### 1 or 2 Stage Heat Pump with S9V2 Furnace

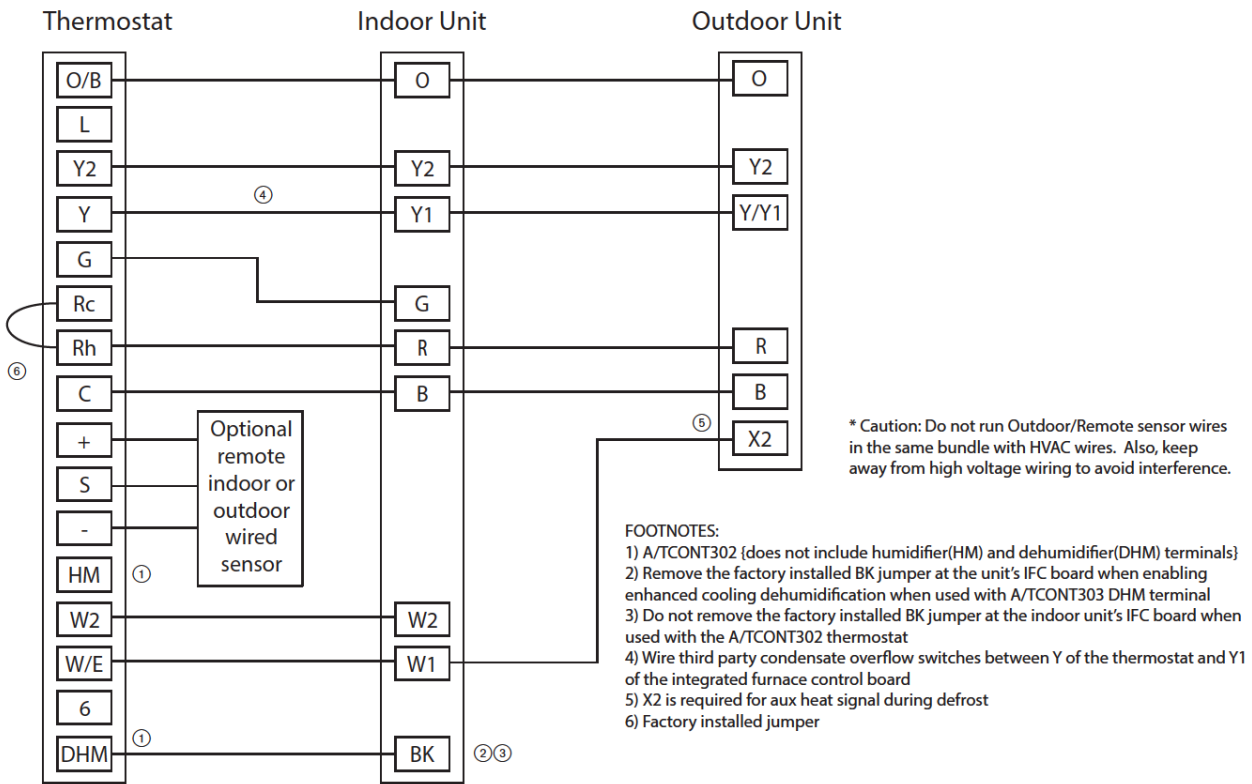

### 1 or 2 Stage Heat Pump with TAM4, GAM5A, GAF2-36M

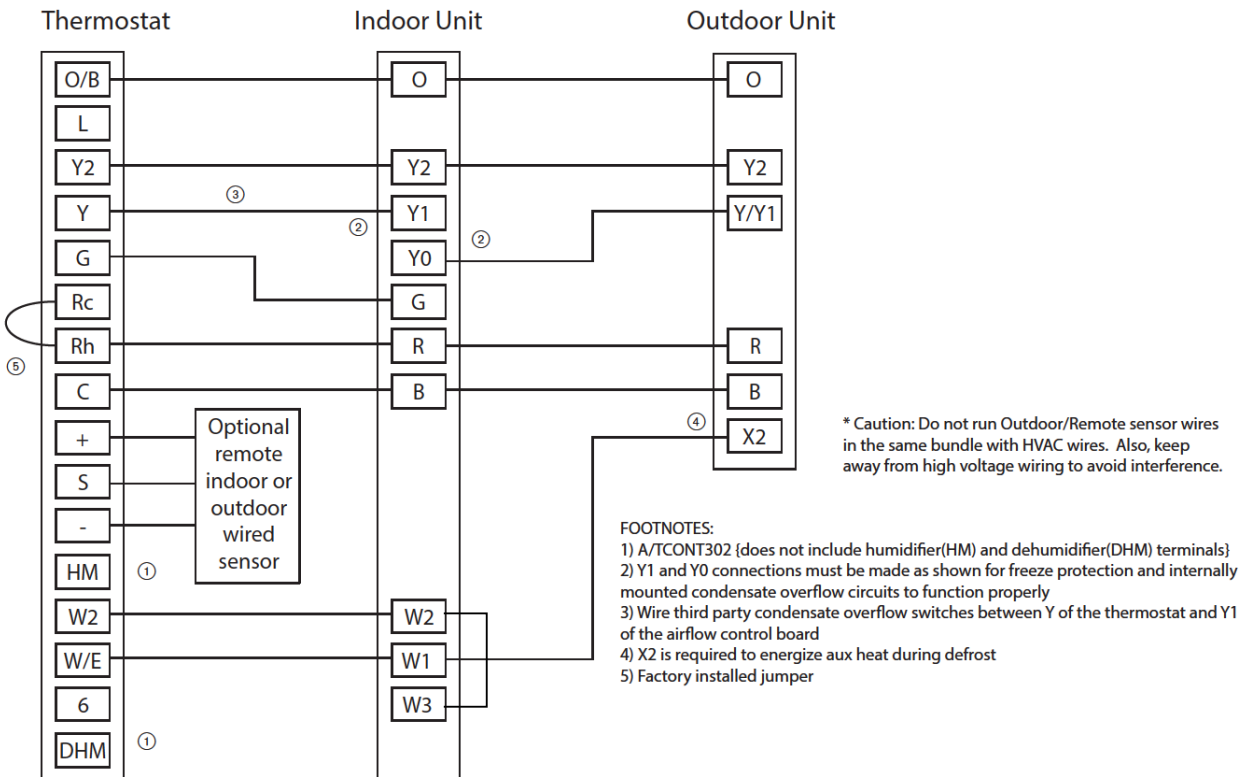

### Heat Pump with GAF2-S

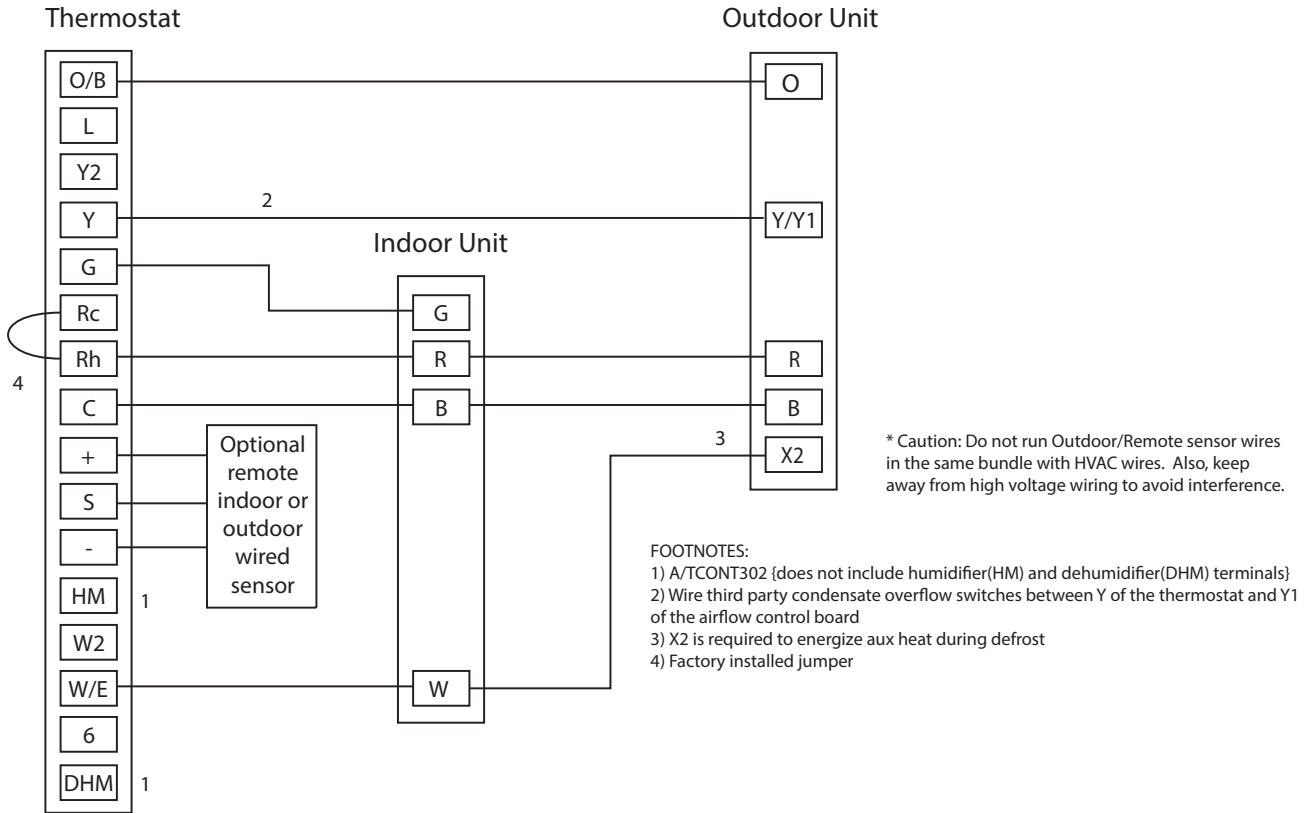

### Package Heat Cool Unit

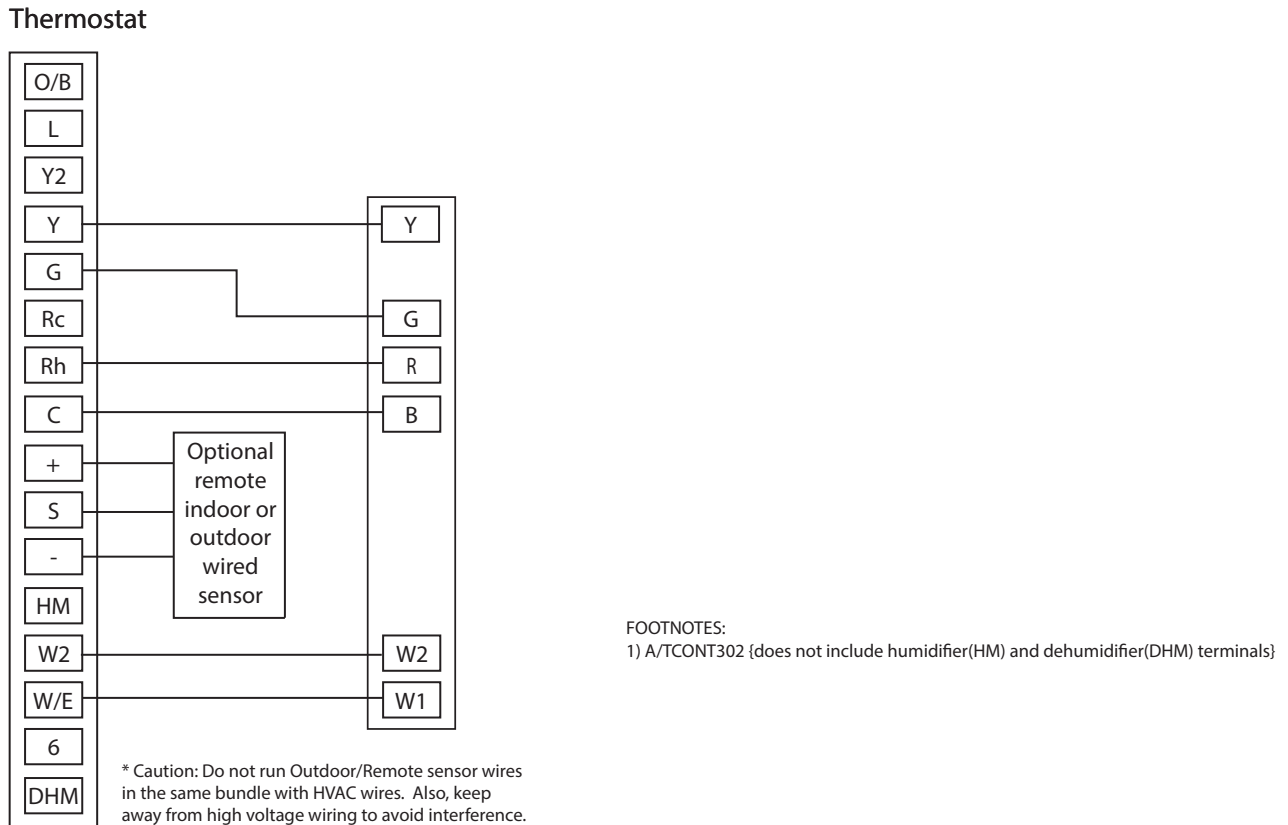

### 1 or 2 Stage Heat/Cool Package Unit with Variable Speed Blower

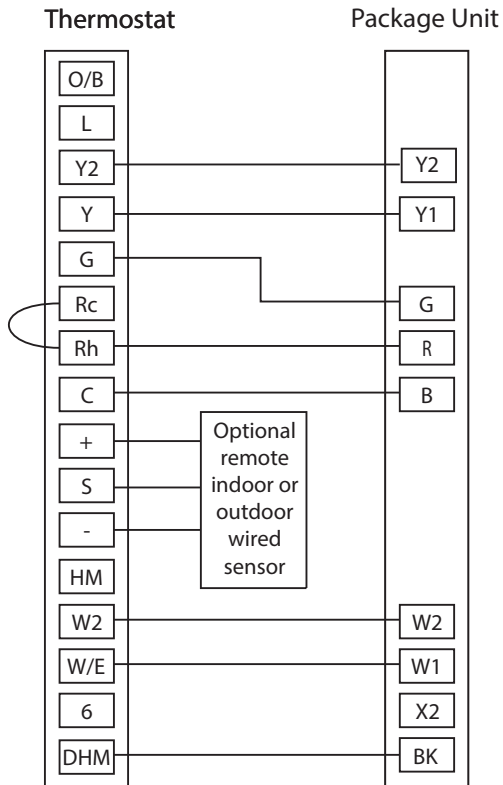

FOOTNOTES:  
 1) A/TCONT302 {does not include humidifier(HM) and dehumidifier(DHM) terminals}

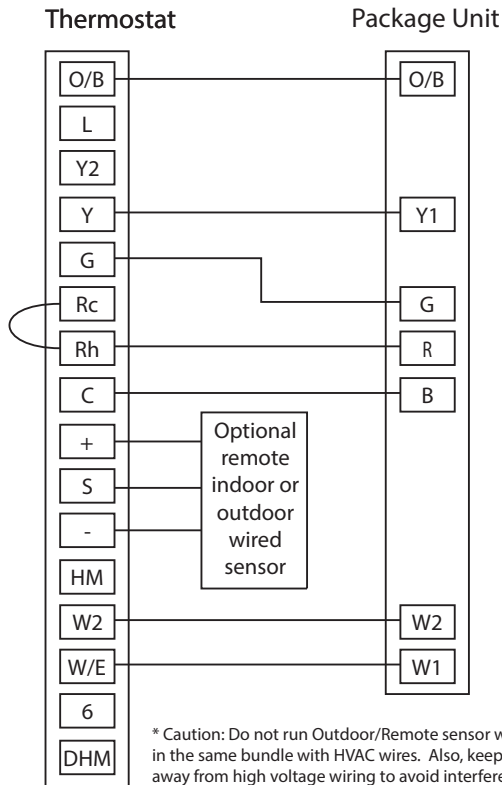

### HP Package Unit with Non-Variable Speed Blower



FOOTNOTES:  
 1) A/TCONT302 {does not include humidifier(HM) and dehumidifier(DHM) terminals}



\* Caution: Do not run Outdoor/Remote sensor wires in the same bundle with HVAC wires. Also, keep away from high voltage wiring to avoid interference.

## 6. Thermostat Quick Reference

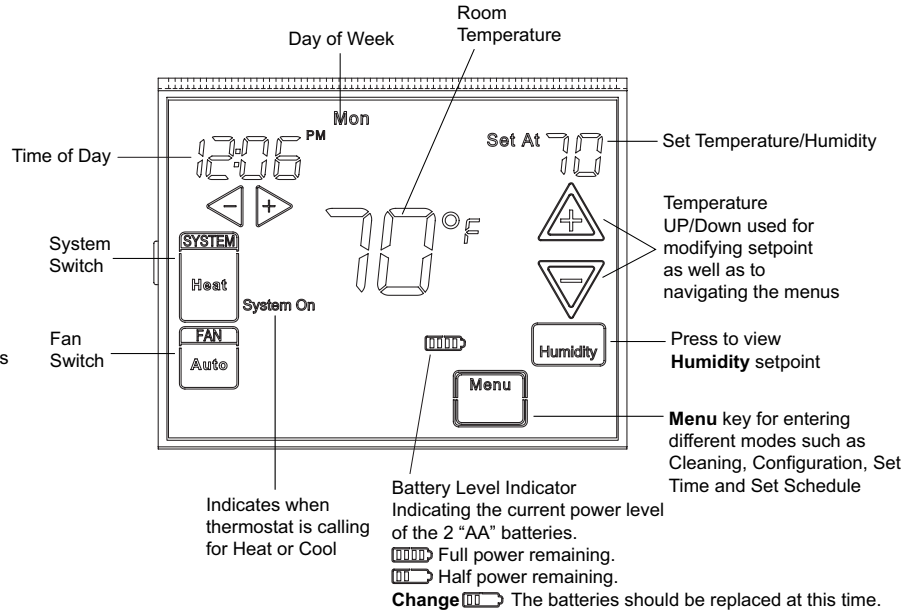
**Note:** If  is displayed, the thermostat is battery powered. When battery power remaining is approximately half,  will be displayed. If the home is going to be unoccupied for an extended period (over 3 months) and  is displayed, the batteries should be replaced before leaving.



### Programming and Configuration Items

- Displays  and "Keypad Lockout" when in keypad lockout mode. Displays  and "Temperature Limit" and "Keypad Lockout" when limited range is activated and locked. Displays only "Temperature Limit" when limited range is activated.
- Indicates period of day being programmed.
- RUN SCHEDULE (run program) key.
- SET TIME key or HOLD temperature key.
- Displays "Change Filter"/"Change Pad"/"Change UV Lamp" when the system has run for the programmed filter/humidity pad/UV lamp time period as a reminder to change or clean your filter/humidity pad or to replace UV lamp.
- COPY key or INSTALLER CONFIG key.
- CLEAN DISPLAY key allows 30 seconds to wipe off the display or ADVANCE DAY key for programming.
- Used in programming to set time and in configuration menu to change selections.
- "Hold Until" indicates the time when a temporary hold period will end.
- "Hours" and "Days" displays during steps in installer configuration.
- The words "Hold At" are displayed when the thermostat is in the HOLD mode. "Temporary Hold At" is displayed when the thermostat is in a temporary HOLD mode.
- "Humidity" indicates that the "Set At" display is Humidity setpoint.
- "System On" indicates when heating or cooling stage is energized. "+2" indicates when a second stage is energized.
- "Copy" indicates the copy program feature is being used during programming.
- A steady "Cool Savings" display indicates the feature is enabled in the installer menu. A flashing "Cool Savings" display indicates the feature is active.
- "Remote" indicates that the indoor remote temperature sensor, is being accessed. "Outdoor Remote" indicates the outdoor remote temperature sensor is being accessed.
- Display time, remote temperature or humidity.
- "Heat Pump" displays when the system configuration is set in HP1/HP2.
- "Call for Service" indicates a fault in the heating/cooling systems. It does not indicate a fault in the thermostat.
- Auto Schedule key for Auto Schedule function or Humidity key to display current Humidity and Humidity setpoint.
- In Configuration Menu, shows screen number.

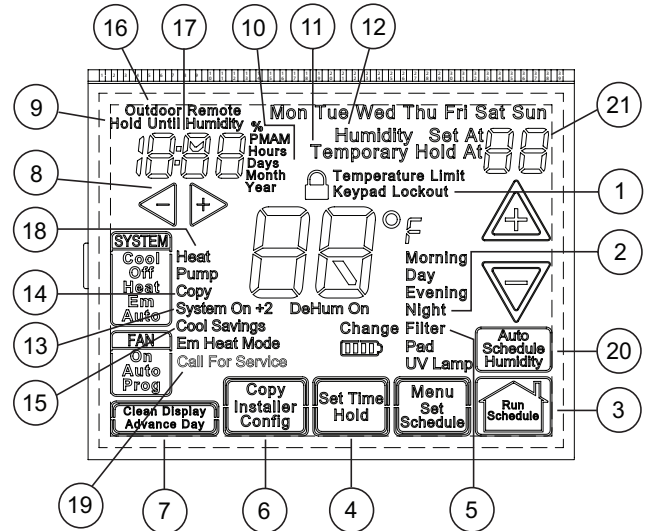





























## 7. Installer Configuration Menu

From the Home Screen: Press **Menu**, then the **Installer Config** touch key and hold for 5 seconds. The Screen Reference number appears in the top right corner of display. See reference numbers in the table below. Screen Reference numbers appear in top right corner of display. Press  $\blacktriangle$  to advance to the next menu item or  $\blacktriangledown$  to return to a previous menu item. Press  $\blacktriangleright$  or  $\blacktriangleleft$  to change a menu item option. Shaded items are not available if selected for Non-Programmable. Write the options selected in the "Option Selected" column of the menu.

**Installer Note:** To default the programming, clock and Configuration Menu to the Factory Default Settings, press the  $\blacktriangle$ ,  $\blacktriangledown$  and SYSTEM keys simultaneously. The thermostat display will go blank for a few seconds, and then all segments will display momentarily. **For heat pump systems, Configuration Menu items 1 and 3 must be set to match the heat pump system.**



302	303	CONFIGURATION MENU					
Screen Reference Number	SS1 MS2	HP1 HP2	Press key	Displayed Factory (Default)	Press $\blacktriangleright$ or $\blacktriangleleft$ to select from listed options	Comments	Option Selected
1	●	●	$\blacktriangle$	MS 2	HP 1, HP 2, SS 1	Selects Multi-Stage (MS2, No Heat Pump), Heat Pump 1 (HP1, 1 compressor), Heat Pump 2 (HP2, 2 compress or 2 speed compressor), or Single Stage.	
2	●	●	$\blacktriangle$	(gas)	ELE	GAS setting: furnace controls blower. ELE setting: thermostat controls blower.	
3		●	$\blacktriangle$	0b (0)	b	Selects Reversing Valve (This item is only to appear if HP1 or HP2 is selected above.)	
4	●	●	$\blacktriangle$	Days, (7) P	5 or 0	Programs per week. (7 days, 5+1+1 days or non-programmable)	
5	●	●	$\blacktriangle$	(4) PS	2	Programs per day. 4 = Morning, Day, Evening, Night 2 = Day, Night Not available if 4 is 0	
6	●		$\blacktriangle$	Cool-Off-Heat-Auto	Cool-Off-Heat, Heat Off, Heat, Cool-Off, Auto Off	System switch configuration in non heat pump mode.	
		●	$\blacktriangle$	Cool-Off-Heat-Em-Auto	Cool-Off-Heat-Em, Off-Em-Auto	System switch configuration, heat pump mode.	
7	●	●	$\blacktriangle$	(On) E	OFF	Selects Energy Management Recovery. Not available if 4 is 0	
8	●	●	$\blacktriangle$	(FA) Heat, Cr	SL	Selects Adjustable Anticipation, cycle rate, Heat	
9	●	●	$\blacktriangle$	(FA) Cool, Cr	SL	Selects Adjustable Anticipation, cycle rate, Cool	
10		●	$\blacktriangle$	(FA) Cr/AU, Em	SL	Selects Adjustable Anticipation, cycle rate auxiliary, (This item is only to appear if HP1 or HP2 is selected above).	
11	●	●	$\blacktriangle$	(OFF) SC	ON	Selects Stage Cycle Completion On (Off).	
12	●	●	$\blacktriangle$	(OFF) CL	On	Compressor Lockout. Default minimum OFF Time = 5 minutes	
13	●	●	$\blacktriangle$	(OFF) dL	On	Selects Continuous Display backlight.	
14	●	●	$\blacktriangle$	0 (Temperature)	5, LO to 5, HI	Selects Adjustable Ambient Temperature Display [range -5 (LO) to +5 (HI)].	
15	●	●	$\blacktriangle$	°F	°C	Selects °F/°C Display (temperature units in Fahrenheit or Celsius).	
16	●	●	$\blacktriangle$	(On) b	OFF	Selects audible Beeper On/Off.	
17	●	●	$\blacktriangle$	(On) dS	OFF	Selects Daylight Saving Time calculation.	
18	●	●	$\blacktriangle$	(On) Heat, AS	OFF	Selects Automatic Schedule for comfort temperature Programming, heat mode. Not available if 4 is 0	
19	●	●	$\blacktriangle$	(On) Cool, AS	OFF	Selects Automatic Schedule for comfort temperature Programming, cool mode. Not available if 4 is 0	
20	●	●	$\blacktriangle$	(OFF) CS	On	Selects Cool Savings Feature On of Off.	
21	●	●	$\blacktriangle$	CS Cool Savings (3)	1-2-3-4-5-6	Selects amount of Cool Savings adjustment.	
22	●	●	$\blacktriangle$	(Off) CO	On	Select Compressor Optimization	
23	●	●	$\blacktriangle$	(OFF) CA	On	Selects Comfort Alert Feature On or Off	
24	●	●	$\blacktriangle$	(99) Heat, HL	62-98	TEMPERATURE LIMIT, HEAT (max. heat set point).	

302	303	CONFIGURATION MENU						
Screen Reference Number	SS1 MS2	HP1 HP2	Press key	Displayed Factory (Default)	Press  or  to select from listed options	Comments	Option Selected	
25	●	●		(45) Cool, LL	46-82	TEMPERATURE LIMIT, COOL (min. cool set point).		
26	●	●		OFF,  Keypad Lockout	L (total), P (partial), Temperature Limit (limited temperature range)	Selects Keypad Lockout.		
28	●	●		(On) Heat, FS	OFF	Fast second stage of heat (not available if SS1 is selected above).		
29	●	●		(On) Cool, FS	OFF	Fast second stage of cool (not available if SS1 or HP1 is selected above).		
30	●	●		Remote (OFF)	On	Remote temperature sensor, enable/disable.		
31	●	●		Remote, In	Outdoor Remote	Remote temperature sensor (Indoor/Outdoor).		
32	●	●		(On) LS	OFF	Local temp. Sensor enable/disable (only when Indoor Remote is selected On).		
33		●		(OFF) dF	On	Selects Dual Fuel feature On or OFF (this item appears if HP1 or HP2 is selected above).		
34		●		(35) dF	-5 - 50	Selects Dual Fuel setpoint (°F), dF selected On with outdoor sensor available.		
35		●		(05) dF	0 - 09	Selects Dual Fuel setpoint (°F), dF selected On with no outdoor sensor.		
36		●		(60) Cd	0-99	Selects compressor off delay in seconds, dF selected On		
37		●		(80) AO	-5 - 79	Selects Auxiliary Heat cut out temperature. This item appears if HP1 or HP2 is selected and outdoor sensor is installed and enabled.		
<b>302</b>	<b>303</b>	<b>FROM THIS POINT ON REFER TO THE SPECIFIC MODEL FOR THE CORRECT SCREEN REFERENCE NUMBER</b>						
N/A	38		●		(80) bP	79-20	Selects Blower balance point. Selection of 80 disables this feature. This item appears if HP1 or HP2 is selected and outdoor sensor is installed and enabled.	
N/A	39	●	●		(OFF) Hd	on	Selects Humidity Display alternate with time.	
N/A	40	●	●		Humidity 00 (Room Humidity)	-20 LO 20 HI	Selects Humidity Display adjustment.	
N/A	41	●	●		(OFF) HR	LO, HI	Selects Auto Humidity reduction.	
N/A	42	●	●		(OFF) AH	H, C, A	Selects Automatic Humidification.	
N/A	43	●	●		(OFF) CH	On	Selects Cycle Humidifier.	
N/A	44	●	●		OC (0)	od, OFF	Selects Optimum Comfort or Optimum Dehumidification or Off.	
38	45	●	●		(OFF) Change UV Lamp	On	Selects Change UV Lamp feature.	
39	46	●	●		350 Days	25-1975	Change UV Lamp duration days.	
N/A	47	●	●		(OFF) Change Pad	On	Selects Change Humidifier Pad feature.	
N/A	48	●	●		100 Hrs	25-1975	Change Humidifier Pad duration hours.	
40	49	●	●		OFF Change Filter	On	Selects Change Filter feature.	
41	50	●	●		200 Hrs	25-1975	Change Filter duration hours.	

- This control can be configured for:  
**MS2** – Multi-Stage System (2 heat/2 cool)  
**HP1** – Heat Pump with one stage of compressor (2 heat/1 cool)  
**HP2** – Heat Pump with two stage compressor or two compressor system, Gas or Electric backup; (Dual Fuel see screen reference number 33) (4 heat/2 cool)

- SS1** – Single Stage System (3 wire zone see wiring diagrams).
- GAS or Electric (ELE)** fan operation. If the heating system requires the thermostat to energize the fan, select ELE. Select GAS if the heating system energizes the fan on a call for heat. Note: Resetting the thermostat switches the option to GAS.



3. **O/B Terminal selection** – Selects the operation of the reversing valve (when item 1 is set to HP1 or HP2 only). When set to “O” the changeover valve will be energized in COOL to accommodate the majority of heat applications. If the heat pump requires the changeover valve to energize in HEAT, select “B”.
4. **Programs per week** – This control can be configured for 7 independent day or 5+1+1 day programming or nonprogrammable modes. Default is 7-day mode. The display indicates “7 Days” as default. Other options “5 Days” or “0 Days” can be selected. If “0 Days” is selected for non-programmable mode, the step for EMR will be skipped, as this feature will not be available in this mode.
5. **Program Steps per day** – Not available if configured for **non-programmable. This control can be configured for 4 or 2 program steps per day.** Default is “4 PS” and can be toggled between 4 PS and 2 PS.
6. **System Switch Configuration (MS2/SS1)** – This thermostat is configured for Heat and Cool with Auto changeover default (Cool-Off-Heat-Auto). It can be configured as Heat & Cool (Cool-Off-Heat), or Heat Only (Off-Heat), or Cool Only (Cool-Off). When the control is in heat pump configuration (HP1/HP2), the system switch configuration will have an additional mode, Em for Emergency.
7. **Energy Management Recovery (EMR)** – (this step is skipped if configured as non-programmable). When set to “On” causes the thermostat to start heating or cooling early to make the building temperature reach the program setpoint at the time you specify. Example: The heating program is 65°F at night and 70° at 7 AM. If the building temperature is 65°F, the difference is 5°F. Allowing 5 minutes per °F rise, the thermostat setpoint will change to 70° at 6:35 AM. Cooling allows more time per °F, because it takes longer to reach temperature.
- 8, 9 & 10 **Cycle Rate Selection - Heat, Cool, EM**  
The factory default setting is fast cycle (FA Cr) in all modes (Heat, Cool, Em). To change to slow cycling (SL, Cr), press touch keys  or  toggle between FA & SL. The cycle rates are below:

Mode	Med	Slow
Heat	0.6°F	1.5°F
Cool	1.2°F	1.7°F
Heat Pump	1.2°F	1.7°F
Emer Heat	0.6°F	1.7°F
11. **Stage Cycle Completion (SC On)** will cause the thermostat to complete heating and/or cooling cycles on the highest stage engaged during the cycle. Thermostat will not reduce heating or cooling stages before the heating or cooling cycle is satisfied and all stages are turned off.
12. **Select Compressor Lockout (CL)** – Selecting (CL On) will cause the thermostat to wait 5 minutes between cooling cycles. This is intended to help protect the compressor from short cycling. Some of the newer compressors have a time delay built in and do not require this feature to be activated in the thermostat. Your compressor manufacturer can tell you if this lockout feature is already present in their system. When the thermostat compressor time delay is activated, it will flash the set point for up to five minutes.



13. **Select Continuous Display Lighting (dL)** – In low lighting conditions, display backlight improves the display contrast.
14. **Select Temperature Display Adjustment 5 LO to 5 HI**  
This allows you to adjust the room temperature display by -5°F to +5°F in 1° steps. Your thermostat was accurately calibrated at the factory, however you have the option to change the display temperature value to match the previous thermostat, if you so prefer.
15. **Select °F or °C Readout** – Changes the display readout to Celsius or Fahrenheit as required.
16. **Select Audio Prompting (Beeper) On or Off** – Factory default setting is b, On. If you wish to turn off the beeper select OFF.
17. **Select Daylight Saving Time Calculation** – This feature will allow the thermostat to calculate the DST automatically and apply it to the Real Time Clock display. Default is On.
18. **Select Automatic Schedule** – Heat Mode –
19. **Select Automatic Schedule** – Cool Mode –  
Not available if configured for non-programmable. This feature allows programming a “Comfort Temperature” into all program periods with the Auto Schedule key. When Heat AS (for Heat mode) or Cool AS (for Cool mode) is selected On, the Auto Schedule feature is ready to be set. Off indicates that the feature is not ready to be used or a “Comfort Temperature” is already set. See Auto Schedule in Programming section.
- 20, 21 **Select Cool Savings™** – Cool Savings™ provides an energy saving temperature offset (from 1-6 degrees) under peak cooling load conditions (high outdoor temperatures). If selected on, Cool Savings™ becomes active when the air-conditioner runs for periods of longer than 20 minutes. When active, Cool Savings™ gradually offsets the indoor temperature display downward. The first 1° of adjustment will take one hour of continuous air conditioner run time with subsequent 1° adjustments occurring with each additional half hour of run time (ex for a 2° offset, the air conditioner would need to run continuously for 1 ½ hours). The offset is limited to the number of degrees you select from 1 up to 6. When an offset starts or is active, “Cool Savings” will flash on the display.  
The principle of this energy saving feature takes advantage of the long air conditioning run times lowering the indoor humidity allowing a slightly higher temperature to feel comfortable. As the peak load subsides, this feature also takes advantage of the air conditioner’s increased capacity under more efficient conditions to gradually reduce the offset back to zero and return control to the selected setpoint temperature. If Cool Savings is selected off, no temperature offset will occur.
22. **Compressor Optimization** – (Not available on earlier models) CO provides a delay in circulator fan operation after the compressor turns on or off. With CO selected ON, when the compressor turns on (for a call for heat in heat pump or a call for cool) the fan will be delayed for five seconds before turning on to allow the air to be heated or cooled. After the compressor turns off for call for cool, the fan will continue to run for 20 seconds to capture additional cooling from the system. If CO is set to OFF, there will be no delay in fan operation.

**23. Comfort Alert with Active Protection** – (For systems that use Comfort Alert.) Turn this feature ON to enable active protection. This allows the thermostat to identify fault codes sent by the Comfort Alert module when compressor damage is possible and react to those codes by turning the compressor off. Fault codes from the Comfort Alert module will flash on the thermostat. If a Comfort Alert module is not connected, or to disable active protection, turn this feature OFF. If a Comfort Alert module is connected and this feature is turned OFF, the thermostat will still receive and flash the fault codes from the Comfort Alert module, but the active protection will not be enabled to protect the compressor.

**24. Heat Temperature Limit Range** – This feature adjusts the highest setpoint temperature for heat. The default setting is 99°F. It can be changed to a setting between 62°F and 98°F. The “**temperature limit**” icon will be displayed to the left of your setpoint temperature when using this feature. The “**temperature limit**” icon will flash if an attempt is made to adjust the temperature beyond the range selected.



**25. Cool Temperature Limit Range** – This feature adjusts the lowest setpoint temperature for cool. The default setting is 45°F. It can be changed to a setting between 46°F and 82°F. The “**temperature limit**” icon will be displayed to the left of your setpoint temperature when using this feature. The “**temperature limit**” icon will flash if an attempt is made to adjust the temperature beyond the range selected.

**26, 27. Keypad Lockout** –

This step allows you to select the type of lockout or limited range security required. If no lockout or limited range security is required, press  to advance the menu. Three security settings are available in this menu item. Use the  or  keys to select the lockout desired.

Lockout selections are:

“**Keypad Lockout and L**” = Total Lockout. Total Lockout locks all keys.

“**Keypad Lockout and P**” = Partial Lockout. Partial Lockout allows only the  or  keys to operate within your set temperature limits

“**Temperature Limit/Keypad Lockout**” prevents changing the temperature limits in the Configuration Menu.



After the type of lockout is selected, press .

**Keypad Lockout Combination Number Selection**

Display will read “000” “**Keypad Lockout**”.

Skip this step and continue through the remainder of the configuration menu if you require an Air Filter Change out indicator or Humidifier Pad Change out indicator by pressing the  key to advance.

Return to this point when you are ready to start your selected lock-out and continue by:

Pressing  or  keys to select your keypad lockout combination number. Note: “000” is not a valid combination choice.

**Record the number you select for future use.**

Press  to exit the menu. The security feature you select will start in 10 seconds. The system key will remain active for 10 seconds to allow setting Heat, Off, Cool or Auto.

To unlock the keypad, press Menu, then press Installer Config. Display will show “000” and keypad lock. Enter the code used to lock the keypad and press .

**28, 29 Select Fast Second Stage, ON or OFF** –

Not available if configured for SS1. Selecting FA ON forces additional heat stages to come on quickly when  is used to raise the temperature a few degrees above the room. Select this setting if you want the heat to increase quickly

when you manually raise the temperature.

Selecting FA OFF allows the thermostat to calculate an optimal time to bring on additional stages of heat. When the  is used to raise the setting above the room temperature additional heat stages may come on very quickly or very slowly (up to 30 minutes later) depending on recent system performance. Select this setting if you do not require the additional heat stages to come on quickly when you manually raise the setting and want to allow the thermostat to stage based on recent system performance. The Fast Cool feature operates the cooling stages in the same manner as Fast Heat, On or Off when the temperature is lowered below the room setting.

**30. Select Remote Temperature Sensor Enabled** – ON enables a remote sensor connected to thermostat and displays the sensor temperature in the clock digits. OFF (default) indicates no remote sensor connected or enabled.

**31. Select Remote Sensor as Indoor or Outdoor** – If 30 is enabled, select Indoor or Outdoor Remote. Default is Remote Indoor.

**32. Select Local Sensor Disable** – If 31 is selected Indoor, the thermostat Local Sensor can be disabled so the displayed temperature will be from the Remote Sensor. Default is On LS. To disable the Local Sensor, change selection to OFF LS.

**33. Select Dual Fuel Feature (dF)** – This feature is applicable only in heat pump modes (HP1, HP2). Enables (On) or disables (Off) dual fuel feature of thermostat.

**34. Select Dual Fuel Temperature** – With dF selected On and outdoor remote sensor available, select the outdoor temperature the thermostat will use to determine when to switch to gas heat and shut down the compressor. When the outdoor temperature falls below the selected temperature the gas heat will begin. Default is 35°, but can be set in the range of -5 to 50°. A lower setting will delay the start of gas heat allowing cooler temperature in the home.

**35. Select Dual Fuel Setting** – With DF selected On and no outdoor sensor, select the dF setting from 01-09. Factory default is 05. The dF setting influences when second stage comes on. The factory default creates a separation of approximately 1°F between stages. Increasing the setting decreases the separation between stages. Decreasing the value increases stage separation. This adjustment allows a small change in the operation of your heat pump system versus your auxiliary system relative to the thermostat adjustment. The higher the number the sooner the auxiliary stage energizes for better comfort. The lower the number the longer period of time before auxiliary is energized for more economy.

**Note:** This setting is not minutes or degrees. It is numeric setting that will influence the internal thermostat calculation for staging.

**36. Select Compressor Delay (Cd)** – For use with Dual Fuel System. After the auxiliary heat is turned on, the compressor(s) shut down is delayed for the time selected (in seconds). This delay is factory set to 60, but can be set in the range of 0 to 99.



**37. Select Auxiliary Off (AO)** – Applicable with HP1 or HP2 selected with outdoor sensor. Select the temperature that will inhibit the auxiliary heating stage. As long as the outdoor temperature is above the selected temperature, the auxiliary heat will not turn on. The default setting is 80°(disabled),





but can be set in the range of -5 ° to 79°. Thermostat will not allow a setting at or below the (dF) dual fuel setting. If indoor temperature drops below 45° because of a possible heat pump malfunction, the thermostat will turn off the pump and switch to Auxiliary heat. “Call for Service” will display on screen. There are two ways the thermostat will return to normal heat pump operation:

- Press any key to retry the pump and erase the “call for service icon.
- When setpoint is achieved on Auxiliary, system will return to heat pump operation on next call for heat.

**From this point on screen reference numbers are specific to either the 302 or the 303 model**

- 38. (303 ONLY) Select Programmable Blower Balance Point (bP)** – Applicable with HP1 or HP2 selected, dF On with outdoor sensor. Requires DHM connection from thermostat to heat pump system. This feature de-energizes the DHM terminal to operate the blower at a slower speed for first stage heat when the outdoor temperature is below the temperature selected. This circulates warmer air than the higher fan speed. The default is 80° (disabled), but can be set from 20° to 79°. Select an outdoor temperature where the air coming out of the ducts begins to feel cool and the thermostat will lower the fan speed to circulate warmer air.
- 39. (303 ONLY) Humidity Display (Hd)** – Selecting HD On enables the display to alternately show the current time and the humidity. If HD is selected OFF, the display will not show the humidity. (See page 10 for Humidity setpoint range)
- 40. (303 ONLY) Adjustable Humidity Display** – The display will show the ambient humidity and 00 (default). The setting can be changed from -20 and LO to 20 and HI. The displayed humidity will change as the offset is changed. In Run mode, the displayed humidity will be the ambient humidity adjusted by the setting selected.
- 41. (303 ONLY) Auto Humidity Reduction (HR)** – This feature automatically lowers humidity setting when the outside temperature drops to prevent the interior windows/walls from reaching the dew point where water condenses on surfaces. This feature default is **OFF**. It can be changed to select **LO** (low humidity reduction) or **HI**. To achieve automatic humidity reduction, the thermostat lowers the humidity when furnace cycles are long. When the outside temperature rises, it increases humidity. “**LO**” indicates a low amount of humidity reduction.
- 42. (303 ONLY) Automatic Humidification (AH)** – This feature if enabled allows for humidification independent of a call for heating – useful in arid climates where addition humidification in heating and/or cooling is desired. If enabled, will energize the humidifier and circulator blower (“**G**” terminal and the “**HM**” terminal) if the actual humidity is below the humidity set point. The display indicates **AH**. Pressing the  key will cycle the display from **OFF** to **H** (feature enabled in Heat mode) to **C** (feature enabled in Cool mode) to **A** (feature enabled to Auto mode) and back to **OFF**.
- 43. (303 ONLY) Cycle Humidifier (CH)** – This feature provides an option that reduces the water usage by up to 50% when a flow-through humidifier is controlled by the thermostat. It is recommended for use on flow-through humidifiers only. The display indicates **CH** (Cycle Humidifier) with the default

indicating OFF. Pressing the  or  keys will toggle the display from **OFF** to **On** and back to **OFF**. When CH is enabled, the humidifier will cycle to turn off for 10 minutes after it has run for 10 minutes. The blower and/or furnace will continue to run during the humidifier off period.

- 44. (303 ONLY) Programmable Dehumidification Optimal Comfort Mode (OC) or Optimal Dehumidification (Od)** – This item can be selected to OC (Optimal Comfort mode), Od (Optimal Dehumidification), or **OFF**. When Optimal Comfort (OC) is enabled, this feature automatically reduces indoor humidity with a call for Cooling if humidity is 2% above humidity setpoint. Humidity is set by pressing the Humidity key when in the appropriate mode, in this case Cooling, and pressing the  or  keys to set desired humidity (range 40% to 95%) level followed by pressing Humidity key again. This dehumidification feature uses less energy by maintaining temperature and dehumidifying only when a call for Cooling is required. Optimal Dehumidification (Od) when enabled, this feature automatically reduces indoor humidity with a call for Cooling if humidity is 2% above setting. Humidity is set by pressing the **HUMIDITY** key when in the appropriate mode, in this case Cooling, and pressing the  or  keys to set desired humidity level followed by pressing Humidity key again. This dehumidification feature may use more energy by making dehumidification a priority initiating a call for cooling if humidity is 2% above desired setting. This feature may also over-cool the condition space by up to 3 degrees to achieve the desired humidity level. (Note: Both dehumidification modes operate in Cooling mode only with a call for cooling)
- 45, 46 on 303 (38/39 on 302) Change UV Lamp** – This feature allows the thermostat to display the words “Change UV Lamp” (Call for Service of UV bulb) after a set time of UV bulb operation. This is a reminder to maintain your UV system at optimum level of operation. When enabled, the factory set interval for “**Change UV Lamp**” to be displayed is 350 days of UV bulb operation and can be adjusted in 25 day increments. This should be adjusted with respect to the bulb’s recommended maintenance schedule. When “**Change UV Lamp**” is displayed, you can clear it by pressing Clean Display.
- 47, 48 (303 ONLY) Change Humidifier Pad** – This feature allows the thermostat to display the words “**Change Pad**” after a set time of humidifier operation. This is a reminder to maintain or clean your humidifier. The factory set interval for “**Change Pad**” to be displayed is 100 hours of humidifier operation. This should be adjusted with respect to the humidifier’s recommended maintenance schedule. When “**Change Pad**” is displayed, you can clear it by pressing Clean Display.
- 49, 50 on 303 (40/41 on 302) Select Change Filter Run Time** – This feature allows thermostat to display “**Change Filter**” after a set time of blower operation. This is a reminder to change or clean your air filter. This time can be set from 25 to 1975 hours in 25 hour increments. A selection of OFF will cancel this feature. When “**Change Filter**” is displayed, you can clear it by pressing Clean Display. In a typical application, 200 hours of run time is approximately 30 days.



## 8. User Guide - Operating Your Thermostat

### CAUTION

Do not allow the compressor to run unless the compressor oil heaters have been operational for 6 hours and the system has not been operational for at least 5 minutes. To prevent compressor and/or property damage, if the outdoor temperature is below 55°F, do not operate the cooling system.

If at any time your system does not operate properly, contact a qualified service person.

### 8.1 Fan Operation

Check thermostat operation. If your system does not have an indoor fan, skip to **Heating System**.

1. Turn on power to system.
2. Press FAN key to **ON** position. The blower should begin to operate.
3. Press FAN key to **AUTO** position. The blower should stop immediately.

### 8.2 Heating

1. Press SYSTEM key to select **HEAT**. If the heating system has a standing pilot, be sure to light it.
2. Press  $\Delta$  to adjust thermostat setting to 1° above the room temperature.
3. The heating system should begin to operate if the compressor lockout time (min. OFF time of 5 minutes is met. If the minimum time is not met the setpoint temperature will flash.
4. The display should show "**System On**". However, if the system configuration is set to HP1 or HP2 and setpoint temperature display is flashing, the 5 minute compressor lockout feature is operating (see Configuration menu, item 11).
5. Adjust temperature setting to 3° above room temperature. If your system configuration is set at MS2, HP1 or HP2, the auxiliary heat system should begin to operate and the display will show "**System On +2**".
6. Press  $\nabla$  to adjust the thermostat below room temperature. The heating system should stop operating.

### 8.3 Humidifier Optional

To check the humidifier when **System On** appears and the heating system is running press the **HUMIDITY\*** button once. Press  $\Delta$  to adjust the humidity 2% or more above the room humidity level setpoint range. (Humidity setpoint can be adjusted from 5 to 50%.)

**Hum On** will appear indicating it is calling for the humidifier.<sup>1</sup>

### 8.4 Emergency Mode Applies only to Heat Pump Systems

Emergency Heat (System EM Position) bypasses the Heat Pump to use the heat source wired to terminal W/E, W2 on the thermostat. EM is typically used when compressor operation is

not desired, or you prefer back-up heat only.

7. Press SYSTEM key to select EM. "EM Heat Mode" will flash on the display.
8. Press  $\Delta$  to adjust thermostat setting above room temperature. The Emergency heating system will begin to operate. The display will show "System On" flashing "EM Heat Mode" and "Heat" to indicate that the Emergency system is operating.
9. Adjust temperature setting to 3° above room temperature. Any additional stages of auxiliary heat should begin to operate and the display will show "System On +2".
10. Press  $\nabla$  to adjust the thermostat below room temperature. The heating system should stop operating.

### 8.5 Cooling

1. Press SYSTEM to select "Cool".
2. Press  $\nabla$  to adjust the thermostat setting below room temperature. The blower should come on immediately on high speed, followed by cold air circulation. The display should show "System On". If the setpoint temperature display is flashing, the compressor lockout feature is operating (see Configuration menu, item 11).
3. Adjust temperature setting to 3° below room temperature. The second stage cooling should begin to operate and the display should show "System On +2".
4. Press  $\Delta$  to adjust the temperature setting above room temperature. The cooling system should stop operating.

### 8.6 Cooling Dehumidification<sup>2</sup>

1. To check the dehumidifier when System On appears and the cooling system is running press **HUMIDITY\*** button once. Press  $\nabla$  to adjust the humidity 2% or more below the room humidity level setpoint range. DeHum On will appear indicating it is calling for the dehumidification.
2. If the room humidity is lower than the adjustment range, press  $\nabla$  to 40% and hold it for four seconds. This will force the DeHum On for one complete cooling cycle to test the dehumidification equipment.
3. After adjusting the humidity setting the display will return to temperature in approximately 10 seconds. To switch the display back to temperature immediately after adjusting humidity setting press **HUMIDITY** again.<sup>1</sup>

### 8.7 Choose the Fan Setting (Auto or On or Prog)

1. **Fan Auto/On – Traditional Fan Settings**  
Press **Fan** to select **Auto** or **On**. The most commonly used setting is Auto. Fan Auto runs the fan only when the heating or cooling system is operating. Selecting **Fan On** runs the fan continuously for increased air circulation or to allow additional air cleaning if the system is equipped with an Electronic Air Cleaner.
2. **FAN Prog – Comfort Circulating Fan Feature**  
**Pressing FAN until FAN Prog appears activates** the Comfort Circulating Fan Option. This causes the thermostat to cycle the fan on for 10 minutes and off for 20 minutes if the thermostat has not called for heat or cool during the past 60 minutes. This assures moderate air

<sup>\*1.</sup> If Auto Schedule is displayed instead of Humidity, Auto Schedule must be turned off in the Configuration Menu

<sup>\*2.</sup> Variable Speed Blower (BK Terminal)

circulation even when the heating and cooling equipment is not cycling.

## 8.8 Choose the System Setting (Cool, Off, Heat, Em, Auto)

Press the SYSTEM key to select:

**Cool:** Thermostat controls only the cooling system.

**Off:** Heating and Cooling systems are off.

**Heat:** Thermostat controls only the heating system.

**Em:** Setting is available only when the thermostat is configured in HP1 or HP2 mode.

**Auto:** Auto Changeover is used in areas where both heating and cooling may be required on the same day. **AUTO** allows the thermostat to automatically select heating or cooling depending on the indoor temperature and the selected heat and cool temperatures. When using **AUTO**, be sure to set the Cooling temperatures more than 1° Fahrenheit higher than the heating temperature.

## 8.9 Manual Operation for Non-Programmable Mode

Press the SYSTEM key to select “Heat” or “Cool” and use the keys to adjust the temperature to your desired setting. After selecting your desired settings you can also press the SYSTEM key to select **AUTO** to allow the thermostat to automatically change between “Heat” and “Cool”.

## 8.10 Manual Operation (Bypassing the Program) Programmable Mode

Manual operation will bypass the program and allow you to adjust the temperature as you desire. The temperature you set in Hold will be maintained indefinitely. Press  $\Delta$  or  $\nabla$  to adjust the temperature. The HOLD key will appear. Press the HOLD key. “Hold At” will appear next to the set point temperature and the thermostat will maintain the new set point temperature until Run Schedule is pressed to resume program operation.

## 8.11 Program Override (Temporary Override)

Press  $\Delta$  or  $\nabla$  keys to adjust the temperature. This will override the temperature setting for a (default) four hour override period. The override period can be shortened by pressing  $\triangleleft$  or lengthened by pressing  $\triangleright$ . Program Override period can range from 15 minutes to 7 days.

**Example:** If you turn up the heat during the morning program, it will be automatically lowered later, when the temporary hold period ends. To cancel the temporary setting at any time and return to the program, press **Run Schedule**.

If the SYSTEM key is pressed to select **AUTO** the thermostat will change to “Heat” or “Cool”, whichever ran last. If it switches to “Heat”, but you want “Cool”, or it changes to “Cool”, but you want “Heat”, press both keys simultaneously to change to the other mode.

# 9. Programming

## 9.1 Set Current Time and Day

1. Press Menu key to enter installer menu. Then press Set Time once to indicate hour & AM or PM designation in clock display.
2. Press and hold either the  $\triangleright$  or  $\triangleleft$  touch key until you reach the correct hour and AM or PM designation.
3. Press Set Time again to display minutes only in clock display.
4. Press and hold either the  $\triangleright$  or  $\triangleleft$  touch keys until you reach the correct minutes.
5. Press Set Time once again to display year.
6. Press either the  $\triangleright$  or  $\triangleleft$  touch key until you reach the correct year.
7. Press Set Time once again to display month.
8. Press either the  $\triangleright$  or  $\triangleleft$  touch key until you reach the correct month.
9. Press Set Time once again to display date of the month along with day of the week at top row (which is automatic).
10. Press and hold either the  $\triangleright$  or  $\triangleleft$  touch key until you reach the correct day of the month and day of the week displayed at the top row.
11. Press Run Schedule once or twice to remove the key. Now the display will show the correct time and room temperature.

### 9.1.1 Automatic Daylight Saving Calculation

The Real Time Clock will adjust automatically for daylight savings time, in the following manner:

Increment one hour at 2 AM on the second Sunday of March and decrement one hour at 2 AM on the first Sunday of November.

The daylight saving feature can be enabled or disabled in installer configuration menu. Default is **DS ON** (enabled).

After entering installer configuration mode, momentarily press touch key until the display indicates dS (in actual temperature digits) and on (default – in clock digits).  $\triangleright$  and  $\triangleleft$  keys will toggle display and operation from on to OFF.

## 9.2 Programming Tip: Copy Program

1. When programming your thermostat, you may copy the program from one day to another day or group of days using the Copy key. In 7 day programming mode, a day can be copied to another day or all six other days. In 5+1+1 day programming mode the weekday (Mon – Fri) program can be copied into Sat and Sun or either Sat or Sun.
2. To copy a program from one day to another:
3. In Set Schedule mode, enter the program for the day or select the day you wish to copy by pressing Advance Day.
4. Press Copy. The display will show “Copy” next to the SYSTEM key and the day of the week that will be copied.
5. Press Advance Day. The day being copied will be indicated and the other days will be flashing.
6. If you wish to copy to all days skip to next step or press Advance Day until the day you wish to copy to is flashing.
7. Press Copy. “Copy” will disappear, the day you copied from will disappear and the day (s) you copied to will be on.
8. If you wish to copy this same program into other days, press Copy and repeat steps 3, 4 and 5.
9. Press Run Schedule to return to normal operation.
10. Fill in the blank schedule provided and then: